



EXCEPTIONAL HARDMOUNT

**HX
FAMILY**

B&C Technologies is expanding worldwide with new lines of washers that have a clear approach to sustainability and are ideal for any type of laundry operation.

This innovative series of machines is designed for performance, reliability, and simplicity. The HX Family uses the highest quality materials to preserve the environment and ensure longevity.

Furthermore, the HX line is surprisingly affordable and ready to solve your pressing laundry needs.

Vended & OPL
22, 35, 50, 65, 85, 110 Pound Capacity

The All New HX Family From B&C Technologies

Experience a revolutionary washer-extractor that raises the standard of washing machine design. After years of research and development, B&C Technologies has created a washer that is uniquely tailored for on premise and vended laundries. Our groundbreaking technology uses the most advanced components, such as the Fuji inverter with special software that monitors the machine's speed, motor current, and balance. Components in the machines are selected to meet the highest quality standards and approvals by world renowned testing authorities. Unique engineering methods and software programs are used to develop an ergonomic, water saving, and sustainable washer that is crafted specifically for laundry operations around the world. With these washers, you will feel empowered and confident in any environment where you need the highest quality of cleanliness.



Along with the exceptional performances of our machines comes the extensive B&C Technologies service and parts availability, capable of handling any issue that may arise. We will be beside you every step of the way, and our goal is to bring more efficient washing and cleanliness to facilities around the world.

Using the latest technology, all designs and stress analyses are made in three dimensions using our advanced computer aided design system. Every detail in the machine is studied for the best performance and longevity. The advanced microprocessor controls provide for the best possible cleaning options. The bearing and seal design is unique and enables the seals to be placed outside the bearing housing meaning the wash solution can never enter the bearings. Service is simple, as the bearing housing assembly can be removed without complete disassembly of the machine. The five degree lean back and ergonomic design of the machine saves water and makes loading, unloading, and operation simple. The stability of the cabinet is exceptional and reduces vibration. Further, the drain valve and other serviceable parts are easy to service. For additional longevity and savings, B&C Technologies washers intentionally use fewer parts than other comparable machines.

A Focus on Technology



Highly Advanced Inverter Drive

Fuji inverters are used in all of our washers and dryers. The Fuji Inverter controls speed, currents and our exclusive out of balance protection allows for maximum extraction force even for difficult to process loads.



The Innovative FM7

The user friendly and flexible FM7 control handles any speed, water level, temperature, and wash profile plus eight liquid injections can be programmed. It provides safe and reliable washing and also handles special wash operations like wet cleaning with no special options. Bluetooth connectivity and our WashTools™ Programming app make commissioning easy.



Durable Door, Door Glass, and Gasket

The polished stainless steel loading door opens 180 degrees for ease of loading and unloading, and operates using high strength cast hinges. The door glass is tempered and silicone gasketing makes for long life, no leaks, and excellent door alignment.

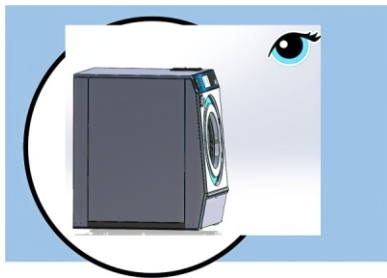

Ergonomic Design

The 5 degree leanback allows for easy loading and unloading and provides visible access to the control panel, a true innovation for user experience. The machine's low profile makes adding wash powders and liquids convenient and safe. 400G versions feature a full stainless steel cabinet.



Rigid and Sturdy Cabinet

Top, front, side, and rear valve panels are made from stainless steel (200G version features powder coated side panels). Four stainless steel corner posts make the cabinet strong, stable, and service friendly, reducing cabinet vibration and noise. Side panels can be removed for easier installation of the machine.

A Focus on Technology

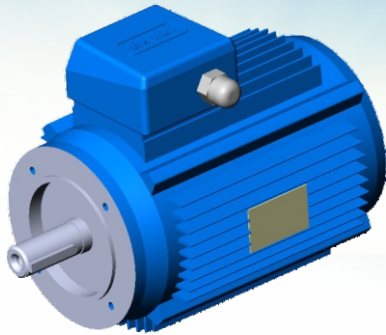

Totally Enclosed Premium Motor

Energy saving, quiet, efficient, and powerful, our easy to service motor is UL and CSA approved. The motor is totally enclosed to shield it against water, humidity, lint and other contaminants. The motor is controlled and protected by the inverter that provides limits in temperature and current, plus the fanless design reduces the parts count of the machine and ensures quiet operation.

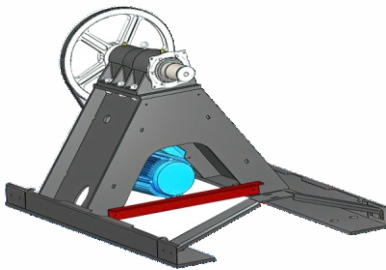

Strong and Durable Frame

The solidly welded powder coated steel frame is simple and durable. Featuring our standard inside/outside bolt hole arrangement, the machine can be easily installed anywhere. The 5 degree lean back design reduces noise, vibration, and bearing loads, increasing the service life of the machine.

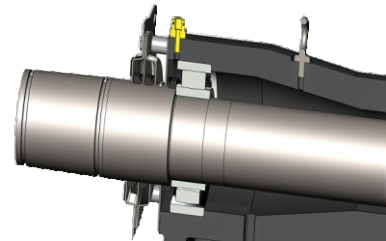

Seals Outside the Bearing Housing

Water cannot enter the bearings due to the spacing between the seals and the bearing housing. Low cost yet effective V-Ring seals are simple to service and provide long life. Viton seals are optionally available for harsher wash solutions and applications.

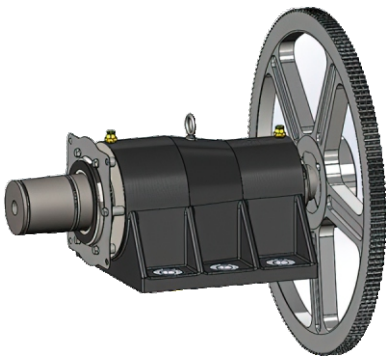

Award Winning Bearing Housing

The unique B&C Technologies CARB bearing design handles bearing misalignment internally for quieter and longer operational life. The bearing housing is high grade ductile iron, and the assembly can be removed from the machine without machine disassembly. 200G versions use our standard roller bearing.

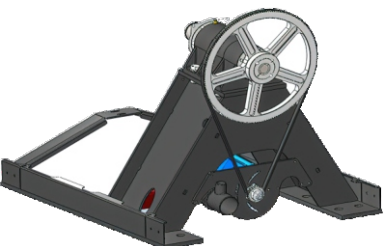

Reliable and Quiet Drive System

The automotive-style timing belt provides lower loads on the motor bearings and eliminates belt tensioners. It cannot slip, is energy efficient, and requires no maintenance.

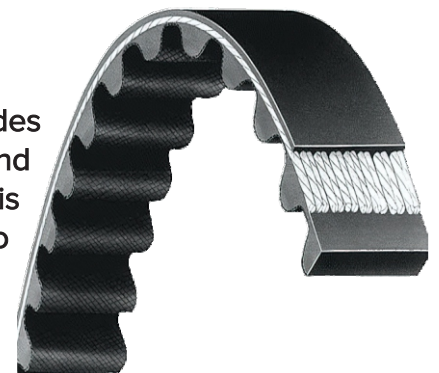

A Focus on Technology



Effective Combination Water Valves

Freely flowing valves quickly fill the washer to the desired level. Service is simple and inexpensive, and the valves meet all international approvals.



Bearing Grease Point

Conveniently located inside the top cover of the machine allowing for easy front service, the bearing grease points can also accept our SKF Automatic Lubrication System, meaning the machine can operate up to one year before canister replacement is needed ensuring a supply of clean and correct grease for the machine.

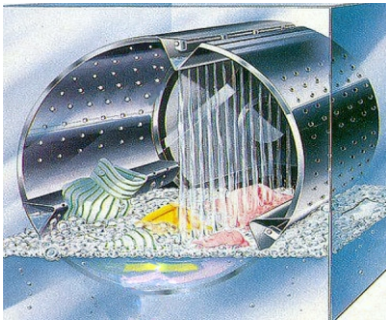

Cascading Water for Faster Wetting

As the cylinder rotates, it lifts up the bath solution and pours it onto the laundry, thereby providing quick absorption into the goods. This helps shorten wash times, saves water, and improves cleaning. The cylinder perforations are optimized for maximum circulation of water and for the ability to extract delicate textiles at high speeds without damage.

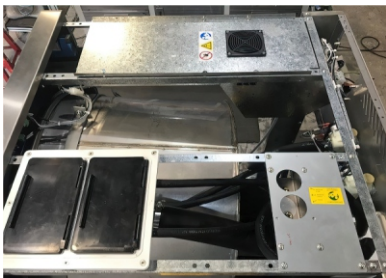

Electronics are Protected

All electrical components are located in a dust free enclosure inside the cabinet. This provides for safer operation and a clean environment inside the machine. A cooling fan with a replaceable filter keeps components comfortable. Truly a clean, easy to service design that protects your investment.

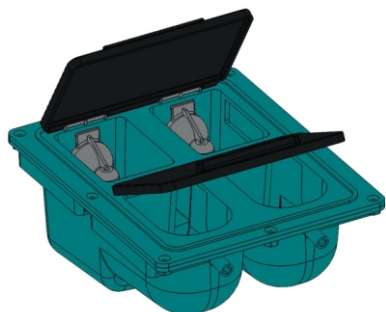

Chemical Dispenser for Powders and Liquids

The dispenser is located on top of the machine and has four compartments - two for powders, and two for liquids. The chemicals are flushed into the wash cylinder via a vacuum breaker in the back of the machine. Chemicals enter the washer under the water level for better dilution and reduced potential for damage.

A Focus on Technology

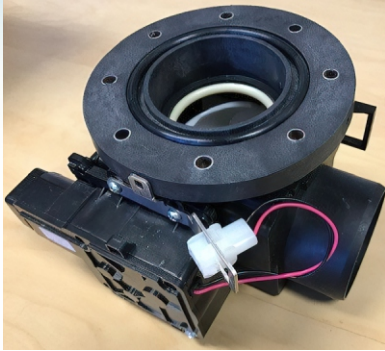

Drain Valve

The drain valve is mounted directly onto the shell and by eliminating the hose that is typically between the shell and drain valve, we can prevent the waste of water and detergent that is idle in that hose. This can conservatively save over 12,000 gallons per year in a 65 pound capacity washer running 10 cycles a day. The drain valve is removed with a quarter turn twist under the front of the machine and features an easily replaceable seal.



Vacuum Breaker

The washers are equipped with an effective vacuum breaker that prevents back flow from the machine into the water supply and prevents suds from backing up through the supply dispenser. The vacuum breaker also features connections for various types of liquid chemicals that are injected under the water level to avoid corrosion and other problems. The design also accommodates pre diluted chemicals (flushing system) which can be connected to a 1/2 inch threaded inlet.

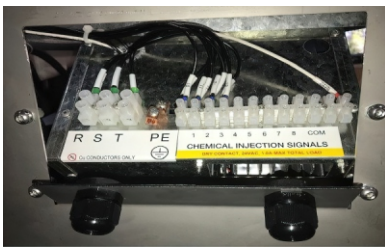

Convenient Power and Chemical Terminals

Connection points are easily accessible, with connection terminals for external liquid systems on the right. No need to open the main control panel when installing the machine or connecting liquid chemical systems.

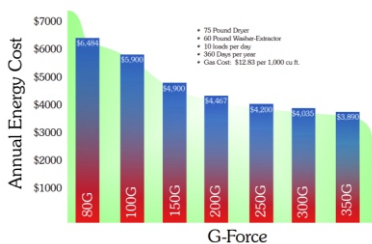

High Speed Saves Money

The standard 200G model features significant savings over older 80G machines and the 400G high speed version reduces the cost of drying even further. Lowering your costs, saving time, and making the laundry operation more efficient is always our design goal.

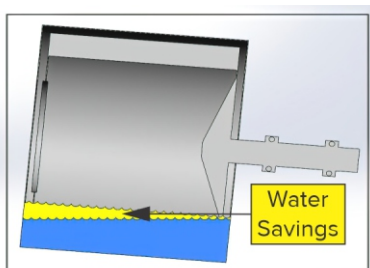

5 Degree Leanback Saves Water and Improves Bearing Life

Bearing loads are much lower as the center of gravity of the load is moved closer to the bearings at the back of the cylinder during high speed extraction, reducing noise and vibration and extending bearing life.

Industries Served



Laundromats

As the need for coin and vended laundries continues to expand, the HX Family of washers are specifically designed to fulfill this increasing demand. Advanced features and ergonomic design make for easy front service and customer use.



Fire Station Laundry

Clean and dry turnout gear is critical for firefighters' safety and health and keeping the gear clean reduces the risk of cancer that is common among firefighters. The HX Family of washers meet or exceed NFPA 1851 specifications. B&C also has drying cabinets designed to dry the gear safely and efficiently, protecting firefighters from steam injuries due to incompletely dry gear.



Hospitality

B&C Technologies equipment is designed for trouble free operation. Using fewer parts reduces down time while increasing productivity. Our machines are made to be affordable and user friendly. Easy to operate controls keep training time to a minimum so you can spend your time taking care of your guests. Vended and OPL laundry operation handles guest laundry and back of house laundry.

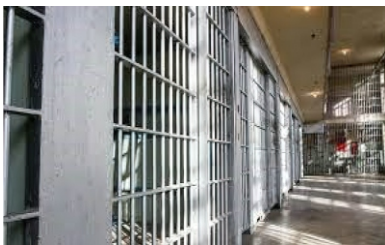

Correctional Facilities

Most correctional facilities have their own laundries for security. No matter the size of the facility, we provide laundry equipment prepared for the environment to reduce the possibility of the machines being damaged or taken apart.



Athletics

Our line of equipment will make sure your team looks their best when it's game time. We understand the high demands that sports uniforms place on laundry and we have machines to meet those demands. Whether it's uniforms or towels the laundry is always clean and fresh while saving you time and money. Our machines extract more water from the goods so they spend less time in the dryer and can have you back on the field sooner.

Industries Served



Industrial Laundries

Industrial laundries process large amounts of harder to clean items daily. Perfect for all applications including hotels, resorts, uniforms, healthcare, and difficult items like mats and carpets or any other large application, our machines are up to the task that industrial laundries require.

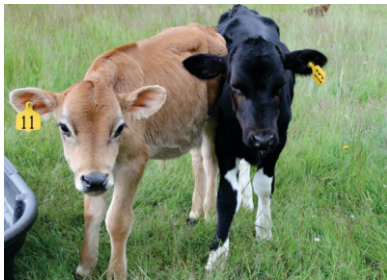

Dairy and Agriculture

The demands of a dairy farm can be tough. You need a washer that's just as tough. Our line of washer-extractors will be able to keep with the busiest of farms. You can count on a B&C machine to get udder cloths clean and virtually dry so you don't have to slow down.



Carwashes

Our durable machines are built to withstand the rigors of the harsher environment present at a car wash. In addition to the rugged design, with a B&C washer you can save money on cleaning supplies. We offer the ability to impregnate cleaning cloths with glass cleaner or many other cleaners so you no longer have to carry around spray bottles.



Commercial Laundry

Most people can't comprehend the amount of laundry to clean each day. We do. We also know that you don't have time to waste with machines that are down. All of our machines are designed to be simple to operate, long lasting, and economical. We designed our complete line to withstand the rigorous demands of a commercial laundry. You can be assured that the processed goods will be clean and fresh.



Drycleaning and Wetcleaning

Whether it's cotton or cashmere we can supply you with a line of equipment that gets clothes clean while saving money and time. When you take a shirt out of a B&C machine it has the perfect moisture content to go straight from the washer to finishing without conditioning. This allows you to save both money and time. If you're considering wetcleaning, you won't need a separate machine as the B&C washer and dryer team has you covered.

Investment

Vended Hardmount, 200G

6 Models:

22, 35, 50, 65, 85, 110 Pounds

OPL Hardmount, 200G & 400G

6 Models:

22, 35, 50, 65, 85, 110 Pounds



Vended Laundry and Laundromats

Laundromats continue to expand globally which leads to a need for effective cleaning of small and large items. The HX family of washers is perfect. Our larger capacity machines provide an opportunity for higher income from customers who need to launder larger items like quilts and comforters - even businesses who need to wash larger items visit laundromats. The new B&C Technologies HX Family washers are available in 22, 35, 50, 65, 85 and 110 pound capacity to meet every need. Utilizing 304 stainless steel in front and top and sides of powder coated galvanized steel allow for long life and a clean look.



Investment



A Full Line of Vended Washers

The most effective coin laundromat is built with washers of various sizes that look and operate the same and provide high quality results, equalling a streamlined and profitable coin store. The innovative technology provided by B&C gives your customers reliability and perfect results. The modern approach to technology yields the highest quality of cleaning and most efficient operation. This is the new era for coin laundries.

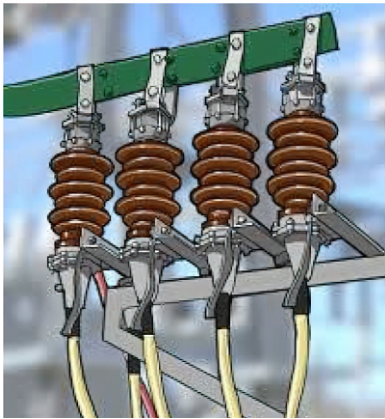

Flexible and Easy Installation

With input voltages available for any location, the machines are easy to install. Making installation even easier, the side panels on machines can be eliminated if installed closely together. Most service can be performed from the front and top, reducing the need to access the rear of the machine.

Intuitive Programmable Control

Our exclusive control saves water and energy and increases productivity. Any wash time, speed, agitation, water level, language, and payment method can be selected. Preferred cycles and options based on individual wash needs can be programmed, including special pricing time-of-day. The customer can select basic programs and choose additions to these programs that fit the needs for any fabrics or garments of various textiles.

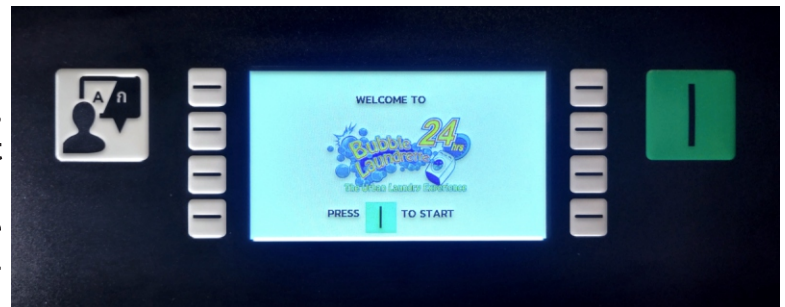

Simple Coin Meter and Secure Coin Box

Available for any single coin or two different coins, this is the standard coin meter offered by B&C. The coin box is strong and vandal resistant. Other more advanced meters and payment systems are also available.



Investment

Advanced Coin Meter System by Münzprüfer

A single coin acceptor handles coin and card, as well as allowing payment through a smartphone. With no unnecessary extra payment devices on your equipment, B&C makes it easy. Any language and any coin can be programmed for use around the world.



Our base level meter is programmable to accept 16 different coin types with over 100 different currencies available and offers a reliable alternative to mechanical coin metering.

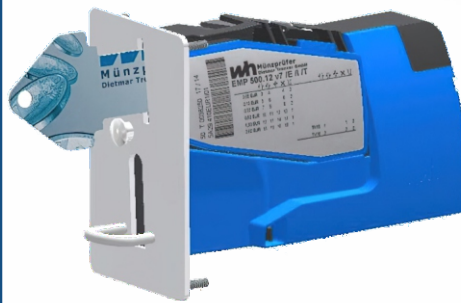

Our second tier meter offers multiple payment methods in one device, and accepts coins and cashless payments.

- 3-in-one payment solution
- Payment by Coins, NFC-Key or via Bluetooth

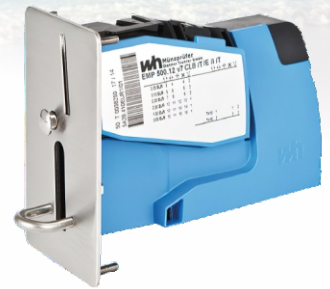

Our most flexible meter offers payment with a smartphone directly at the machine and works with Bluetooth. Paypal and other payment types with a smartphone provide the owner with remote information about the business.



B&C Technologies The B&C Technologies Card dispensing system

FOLLOW INSTRUCTION ON THE SCREEN

PAY MONEY CARD HERE
INSERT OR SWIPE CREDIT CARD

PAY MONEY CARD WITH BANK NOTES HERE

RECEIVE NEW MONEY CARD

CHECK BALANCE ON MONEY CARD HERE

THANK YOU FOR USING OUR PAYMENT SYSTEM

An Innovative Payment System Makes it Easy

The payment system consists of a wall-mounted card dispensing station that accepts any type of payment. Just insert your credit card and purchase a payment key that can be inserted in the coin meter of the washers or dryers. You can use either bills or credit card to pay for the wash cycles you need. The key can be replenished any time for more washing and drying and you can always check how much money you have on the key by inserting it in the dispensing station. The system also accepts other payment methods like PayPal, Apple Pay, and many more.

About B&C Technologies

B&C Technologies designs our laundry equipment and manufactures them in Bangkok, Thailand by Accurate Technologies, a partnership first established in 1996. B&C has over 20,000 laundry machines in operation in the United States, Canada, Central and South America, the Carribean, and over 100,000 in the world.

B&C Technologies and Accurate Technologies have built a world class line of commercial and industrial laundry equipment which is exported worldwide. The combined effort of the two companies has resulted in new innovative laundry technologies to improve washrooms throughout the world.

We are proud to introduce our new line of vended and OPL washer-extractors, the HX Family. This new line has been developed with the goal of helping the world clean more effectively and waste less water and energy during the process. Concern for the environment drives our design process and goes hand in hand with the development of new textiles and new environmentally friendly detergents that can be used in the washers we manufacture.



Our Panama City Beach, Florida Home



We started B&C Technologies with one goal in mind. To provide the highest quality laundry equipment at an affordable price. We started out with less than 10 machines and since that time we have worked hard to offer the largest variety of equipment to meet most laundry needs. Now with over 100 different products available we are the laundry solution. We strive to continue to be pioneers with our innovative products and technologies that have helped us to become industry leaders.

In addition to the high standards we have set for our equipment, we have also set those same high standards for ourselves. We have built a foundation on innovation, dependability, and a set of solid values that have guided us and allowed us to build a strong, talented team. We are excited about the future growth of B&C Technologies as we strengthen our industry position. As we continue to grow we will maintain the family atmosphere and close, personal relationships that set us apart. Welcome to the B&C family.

Designed for Reliability

The Importance of Reliability and Affordability

Investment in a vended laundry is a serious matter as the equipment needs to be reliable and quickly provide a return on that investment. B&C Technologies has developed this new concept with the following in mind:

- Built with reliable components that are certified by authorities like UL, ETL, CSA, CE and others.
- Manufactured to meet exacting safety standards and other quality requirements in an ISO9000 certified facility.
- Designed simply to use fewer parts for efficiency and lower costs.
- All parts are manufactured to strict specifications and with thorough quality inspections.



Our goal is to manufacture equipment which is reliable and affordable. To reach this goal, each design is rigorously tested, analyzed, and improved over time. The HX Family of machines has been thoroughly researched to live up to these standards. Innovation is the driver of great performance.

60/36 Warranty



60 Months: Bearings, Bearing Housing, Frame, Shaft, Cylinder & Shell
36 Months: All other non wear parts



Designed for Today and Tomorrow

Save Water & Natural Resources

The many features of the B&C vended and on-premises washers result in water savings that help us do our part in respecting the world around us. Now more than ever, the importance of saving water cannot be overstated. With B&C, you will achieve long term savings with many innovative features that reduce energy consumption and cycle times. The ergonomic design creates an outstanding user experience that prevents confusion and increases productivity. We invite you to try this new line of washers and experience a well executed design that truly makes washing a pleasure.



Increase Profits with Larger Machines

Consider leaving space for larger machines that can handle comforters, blankets, rugs, sleeping bags, pillows, and other bulky items. This will draw customers from rentals and small hotels that are not equipped with larger machines. Further, it opens your business to wash-dry-fold and to commercial accounts. These washer-extractors can be connected to automatic detergents and chemical injection systems, which open up the use for ozone or other sanitary chemical programs that are important in the hospitality industry. Large machines also cost less than smaller machines per pound of capacity, and provide more output per square foot of floor space.

Tourism and Baby Boomers Will Impact Vended and On Premise Laundries

The outlook for residents and international travelers in the United States is astronomical. Tourists spend approximately \$2.8 billion dollars a day, \$110 million a hour, \$2 million a minute, and \$32,800 a second. This indicates that the laundry business is sustainable, as visitors utilize establishments that provide laundry services like hotels, bed and breakfasts, hostels, restaurants, and airlines. Jobs supported by travel expenditures is \$8.8 million directly in the travel industry and \$6.8 million in other industries.

Aging baby boomers will have a major impact on the nursing home industry, as well as other medical facilities. These typically operate their own laundries on-site and most nursing homes and long term care centers have in-house laundries as well. Efficient laundries with more reliable machines that save water, supplies, and energy, and that are gentle to the environment will continue to be in demand.

Vended Specifications

MODEL			HXC-22		HXC-35		HXC-50		HXC-65		HXC-85		HXC-110	
UNITS	METRIC	US	METRIC	US	METRIC	US	METRIC	US	METRIC	US	METRIC	US	METRIC	US
CAPACITY														
Loading Factor 1:10	kg	LBS	8.24	18.2	13.5	29.7	19.6	43.2	27.5	60.6	36	79.3	45.4	100
Loading Factor 1:13	kg	LBS	6.34	14	10.4	22.9	15.7	34.6	21.2	47.7	27.7	61	34.9	76.9
OVERALL DIMENSIONS														
A-Width	mm	Inch	660	26	770	30.3	770	30.3	876	34.5	1051	41.4	1051	41.4
B-Depth	mm	Inch	864	34	990	39	1092	43	1168	46	1167	46	1394	55
C-Height	mm	Inch	1028	40.5	1130	44.5	1226	48.3	1334	52.5	1591	62.6	1591	62.6
WASH CYLINDER														
Diameter	mm	Inch	526	20.7	610	24	681	26.8	790	31.1	920	36.2	920	36.2
Depth	mm	Inch	379	14.9	462	18.2	539	21.2	561	22	544	21.3	683	26.9
Volume	liters	cu.ft	82.4	2.91	135	4.77	196	6.93	275	7.71	360	12.7	454	16.1
MOTOR														
Size	kW	HP	0.76	1	1.5	2	2.2	3	3	4	5.5	7.5	7.5	10
CYLINDER SPEED PROGRAMMABLE														
Wash	rpm	G	52	0.8	49	0.8	46	0.8	43	0.8	40	0.8	39.5	0.8
Distribution	rpm	G	100	3	94	3	89	3	82	3	76	3	76	3
Extract maximum	rpm	G	818	200	760	200	726	200	673	200	623	200	622	200
DOOR OPENING														
Door opening diameter	mm	Inch	381	15	418	16.5	483	19	508	20	651	25.6	668	26.3
Height to bottom of door	mm	Inch	324	12.8	349	13.4	401	16	422	16.6	569	22.4	582	22.9
DRAIN SYSTEM														
Drain outlet size	mm	Inch	51	2	51	2	51	2	76.2	3	76.2	3	76.2	3
Number of drains	Standard	Standard	1	1	1	1	1	1	1	1	1	1	1	1
STEAM INLET														
Connection size	DN	NPT	13	1/2	13	1/2	13	1/2	13	1/2	20	3/4	20	3/4
ELECTRICAL HEATING														
Heating element size	kW	kW	6	6	9	9	12	12	18	18	18	18	24	24
WATER INLETS														
Connection size	DN	NPT	20	3/4	20	3/4	20	3/4	20	3/4	20	3/4	20	3/4
Numbers of inlets	Standard	Optional	2	3	2	3	2	3	2	3	2	3	2	3
CHEMICAL SYSTEM														
Number of dry chemicals	Standard	Standard	2	2	2	2	2	2	2	2	2	2	2	2
Number of liquid chemicals	Standard	Standard	2	2	2	2	2	2	2	2	2	2	2	2
External liquid connection	Standard	Standard	8	8	8	8	8	8	8	8	8	8	8	8
WEIGHT & SHIPPING INFORMATION														
Net weight	kg	lbs	199	439	288	635	345	760	429	944	TBA	TBA	TBA	TBA
Shipping weight	kg	lbs	213	470	304	670	360	795	450	990	TBA	TBA	TBA	TBA
Shipping size: Width-Depth-Height	cm	inch	71-96-121	28-38-48	81-109-132	32-43-52	84-119-140	33-47-55	94-134-146	37-53-57.5	TBA	TBA	TBA	TBA
ELECTRICAL SERVICE														
120VAC, 50HZ, 1PH	Amp	Breaker	TBA	TBA	TBA	TBA	N/A	N/A	N/A	N/A	N/A	N/A	N/A	N/A
208-240VAC, 50-60HZ, 1PH	Amp	Breaker	6	15	8.1	15	5.1	15	16.1	20	22	30	31	40
208-240VAC, 50/60HZ, 3PH	Amp	Breaker	3.4	15	3.6	15	4.7	15	7.4	15	12.7	20	18	30
380-460VAC, 50/60HZ, 3PH	Amp	Breaker	1.7	15	1.8	15	2.3	15	3.5	15	6.3	15	9	15
208-240VAC, 50/60HZ, 3PH EL Heat	Amp	Breaker	24	30	26	30	48	60	52	60	75	80	78	80
380-460VAC, 50/60HZ, 3PH EL Heat	Amp	Breaker	13	15	14	15	24	30	26	30	38	40	39	40

Specifications subject to change without notice.



B&C Technologies
Panama City Beach, FL
850-249-2222
www.bandctech.com
sales@bandctech.com

60/36 Warranty



60 Months: Bearings, Bearing Housing, Frame, Shaft, Cylinder & Shell
36 Months: All other non wear parts

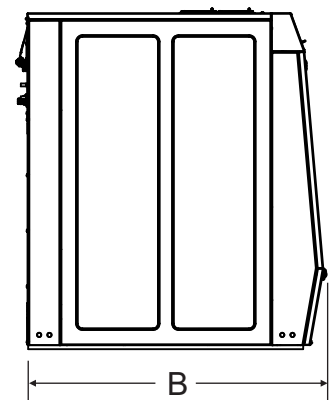
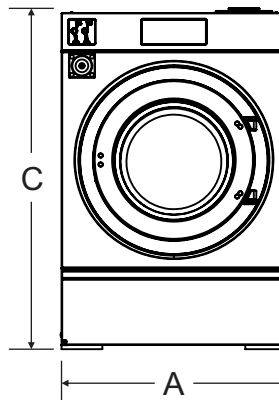

OPL Specifications

MODEL			HXO-22		HXO-35		HXO-50		HXO-65		HXO-85		HXO-110	
UNITS	METRIC	US	METRIC	US	METRIC	US	METRIC	US	METRIC	US	METRIC	US	METRIC	US
CAPACITY														
Loading Factor 1:10	kg	LBS	8.24	18.2	13.5	29.7	19.6	43.2	27.5	60.6	36	79.3	45.4	100
Loading Factor 1:13	kg	LBS	6.34	14	10.4	22.9	15.7	34.6	21.2	47.7	27.7	61	34.9	76.9
OVERALL DIMENSIONS														
A-Width	mm	Inch	660	26	770	30.3	770	30.3	876	34.5	1051	41.4	1051	41.4
B-Depth	mm	Inch	864	34	990	39	1092	43	1168	46	1167	46	1394	55
C-Height	mm	Inch	1028	40.5	1130	44.5	1226	48.3	1334	52.5	1591	62.6	1591	62.6
WASH CYLINDER														
Diameter	mm	Inch	526	20.7	610	24	681	26.8	790	31.1	920	36.2	920	36.2
Depth	mm	Inch	379	14.9	462	18.2	539	21.2	561	22	544	21.3	683	26.9
Volume	liters	cu.ft	82.36	2.9	135	4.8	196	6.9	275	9.7	362	12.7	454	16
MOTOR														
Size	kW	HP	0.76	1	1.5	2	2.2	3	3	4	5.5	7.5	7.5	10
CYLINDER SPEED PROGRAMMABLE														
Wash	rpm	G	52	0.8	49	0.8	46	0.8	43	0.8	40	0.8	39.5	0.8
Distribution	rpm	G	100	3	94	3	89	3	82	3	76	3	76	3
Extract maximum	rpm	G	818	200	760	200	725/1025	200/400	673/950	200/400	623/880	200/400	623/880	200/400
DOOR OPENING														
Door opening diameter	mm	Inch	381	15	418	16.5	483	19	508	20	651	25.6	668	26.3
Height to bottom of door	mm	Inch	324	12.8	349	13.4	401	16	422	16.6	569	22.4	582	22.9
DRAIN SYSTEM														
Drain outlet size	mm	Inch	51	2	51	2	51	2	76.2	3	76.2	3	76.2	3
Number of drains	Standard	Standard	1	1	1	1	1	1	1	1	1	1	1	1
STEAM INLET														
Connection size	DN	NPT	13	1/2	13	1/2	13	1/2	13	1/2	20	3/4	20	3/4
ELECTRICAL HEATING														
Heating element size	kW	kW	6	6	9	9	12	12	18	18	18	18	24	24
WATER INLETS														
Connection size	DN	NPT	20	3/4	20	3/4	20	3/4	20	3/4	20	3/4	20	3/4
Numbers of inlets	Standard	Optional	2	3	2	3	2	3	2	3	2	3	2	3
CHEMICAL SYSTEM														
Number of dry chemicals	Standard	Standard	2	2	2	2	2	2	2	2	2	2	2	2
Number of liquid chemicals	Standard	Standard	2	2	2	2	2	2	2	2	2	2	2	2
External liquid connection	Standard	Standard	8	8	8	8	8	8	8	8	8	8	8	8
WEIGHT & SHIPPING INFORMATION														
Net weight	kg	lbs	199	439	288	635	345	760	429	944	TBA	TBA	TBA	TBA
Shipping weight	kg	lbs	213	470	304	670	360	795	450	990	TBA	TBA	TBA	TBA
Shipping size: Width-Depth-Height	cm	inch	71-96-121	28-38-48	81-109-132	32-43-52	84-119-140	33-47-55	94-134-146	37-53-57.5	TBA	TBA	TBA	TBA
ELECTRICAL SERVICE														
120VAC, 50HZ, 1PH	Amp	Breaker	TBA	TBA	TBA	TBA	N/A	N/A	N/A	N/A	N/A	N/A	N/A	N/A
208-240VAC, 50-60HZ, 1PH	Amp	Breaker	6	15	8.1	15	5.1	15	16.1	20	22	30	31	40
208-240VAC, 50/60HZ, 3PH	Amp	Breaker	3.4	15	3.6	15	4.7	15	7.4	15	12.7	20	18	30
380-460VAC, 50/60HZ, 3PH	Amp	Breaker	1.7	15	1.8	15	2.3	15	3.5	15	6.3	15	9	15
208-240VAC, 50/60HZ, 3PH EL Heat	Amp	Breaker	24	30	26	30	48	60	52	60	75	80	78	80
380-460VAC, 50/60HZ, 3PH EL Heat	Amp	Breaker	13	15	14	15	24	30	26	30	38	40	39	40

Specifications subject to change without notice.



B&C Technologies
Panama City Beach, FL
850-249-2222
www.bandctech.com
sales@bandctech.com

60/36 Warranty



60 Months: Bearings, Bearing Housing, Frame, Shaft, Cylinder & Shell
36 Months: All other non wear parts

